

Digital Display Proportional Valve Driver

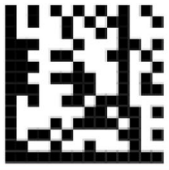

LE PM X

Direct DIN Solenoid Mount With
4 Pin, M12 Connector

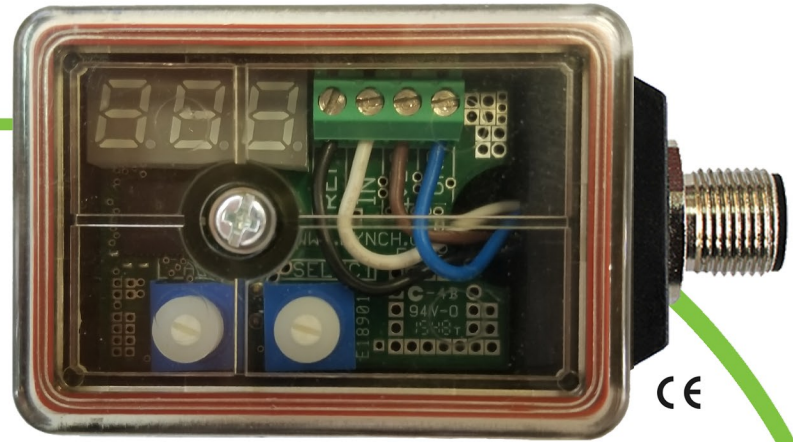

Features and Benefits

- ▶ Microcontroller design.
- ▶ Independent adjustments (Incl. ramp up & ramp down).
- ▶ 4 digit extra bright seven segment LED display.
- ▶ Large, easy-to-use adjustments and readout.
- ▶ Display and adjust actual values (Current & Voltage).
- ▶ Wide range of supply voltage.
- ▶ User selectable input type through menu setup.
- ▶ Wide ramp time range (0 to 99.5 Sec).
- ▶ Simple control with analog input, locally supplied reference voltage.
- ▶ Energy efficient PWM circuit/no heat sink required.
- ▶ Electronic limiting circuit/short circuit proof.
- ▶ Reverse polarity, command Input protection.
- ▶ Load can be connected & disconnected live.
- ▶ Current sensing maintains output regardless of changes in supply voltage and coil resistance.
- ▶ Easy troubleshooting/cable length not an issue.
- ▶ 4 pin M12 connector.

LE PM X Standard Specifications

Operating voltage:	9 to 36 VDC
Maximum output current:	3.00Amps
Input signal:	5V, 10V, 4 to 20mA
Maximum ramp time:	99.5 Sec
PWM / Dither frequency:	40-450Hz
Linearity:	1%
Operating Temperature:	-40° to +75° Celsius
Protection Grade:	IP65 (See note on the next page for additional information)

Several Forms Available



Note: Customization of functionality and enclosure type are available on request.

PART NUMBER SYSTEM

Proportional Solenoid Driver, Single, solenoid mount with 4 pin M12 connector **Example: LE PM X**

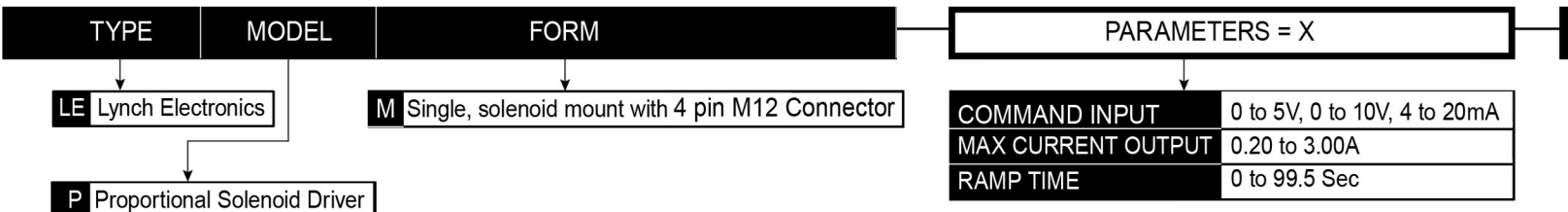

Contact Us For More Information

Toll Free Tel: 1 (888) 626-4365 Fax: 1 (800) 263-5807	Local & International Tel: +1 (905) 363-2400 Fax: +1 (905) 363-1191	Canada 1799 Argentia Road Mississauga, Ontario L5N 3A2	USA 3790 Commerce Court, Suite 500, North Tonawanda New York, 14120	Online www.Lynch.ca sales@lynch.ca
--------------------------------------------------------------------	--------------------------------------------------------------------------------------	---------------------------------------------------------------------	-------------------------------------------------------------------------------------	-------------------------------------------------

LE PMX-1017

LE PM X

SCHEMATICS

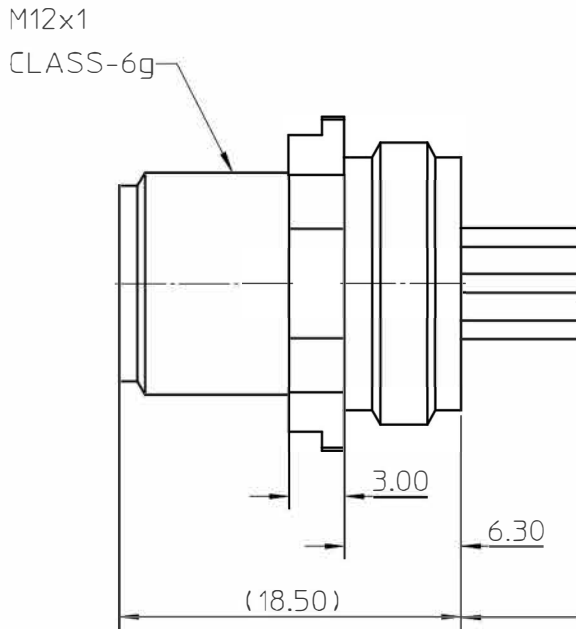

Male Face View - 4 Wires

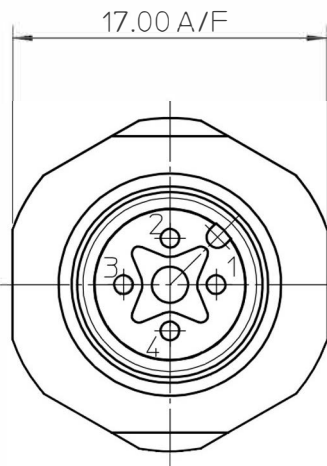
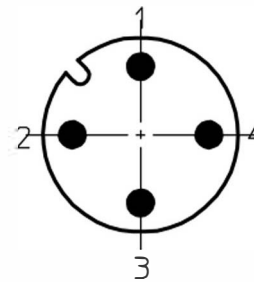

PIN No.	WIRE	WIRING CONNECTION
1	Brown	+VDC
2	White	IN
3	Blue	GND
4	Black	5V REF

PLEASE NOTE: For “0 to 5 VDC” & “0 to 10 VDC” command input drivers, it is recommended to use independent negative conductors for power supply and analogue output channel (PLC/PC) to maintain command signal accuracy due to voltage drop on long cable runs.



This product has been designed and tested to meet specific standards outlined in the European Electromagnetic Compatibility Directive (EMC) 2004/108/EC
 Emission: EN 61000-6-4: 2007
 Immunity: EN 61000-6-2: 2005, EN 61000-4-2, EN 61000-4-4, EN 61000-4-6
 RoHS: EN 50581:2012

Contact Us For More Information

Toll Free Tel: 1 (888) 626-4365 Fax: 1 (800) 263-5807	Local & International Tel: +1 (905) 363-2400 Fax: +1 (905) 363-1191	Canada 1799 Argentia Road Mississauga, Ontario L5N 3A2	USA 3790 Commerce Court, Suite 500, North Tonawanda New York, 14120	Online www.Lynch.ca sales@lynch.ca
--------------------------------------------------------------------	--------------------------------------------------------------------------------------	---------------------------------------------------------------------	-------------------------------------------------------------------------------------	-----------------------------------------------------------------------------------------------------------------------

LE PM X-1017

LE PM X

SCHEMATICS

EXTERNAL INPUT SIGNAL CONNECTION

“in” set to “10”

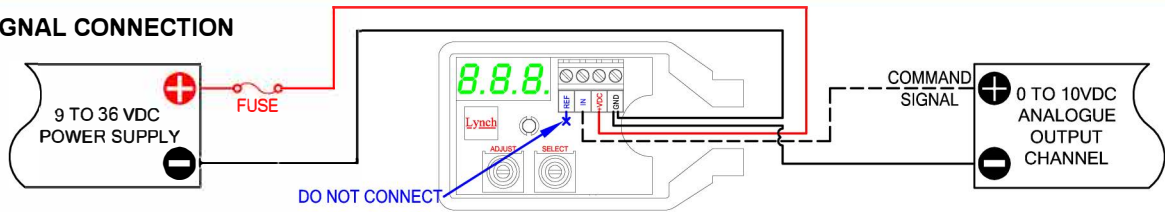

POTENTIOMETER CONNECTION

“in” set to “5”

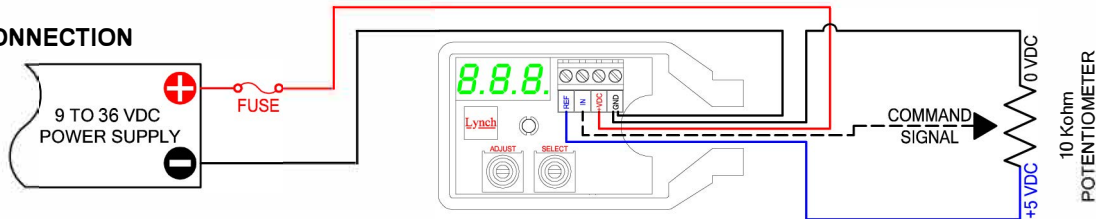

RAMP UP & DOWN ONLY OPERATION

“in” set to “5”

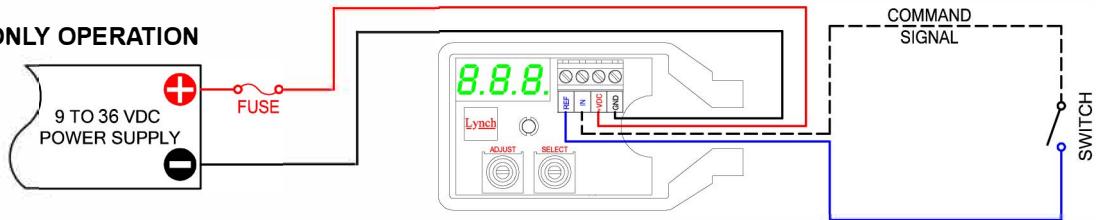

EXTERNAL INPUT SIGNAL CONNECTION

“in” set to “420”

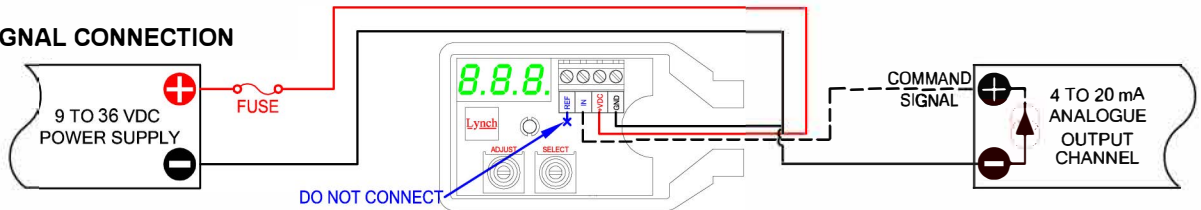

TWO WIRE TRANSMITTER INPUT CONNECTION

“in” set to “420”

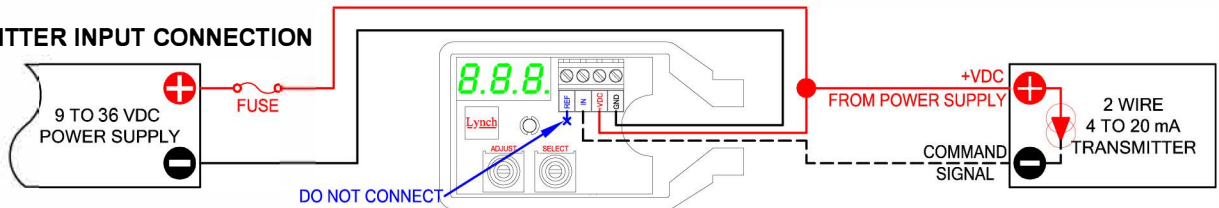

PLEASE NOTE: For “0 to 5 VDC” & “0 to 10 VDC” command input drivers, it is recommended to use independent negative conductors for power supply and analogue output channel (PLC/PC) to maintain command signal accuracy due to voltage drop on long cable runs.



This product has been designed and tested to meet specific standards outlined in the European Electromagnetic Compatibility Directive (EMC) 2004/108/EC
 Emission: EN 61000-6-4: 2007, EN 55011:2009
 Immunity: EN 61000-6-2: 2005, EN 61000-4-2, EN 61000-4-3, EN 61000-4-4, EN 61000-4-6, EN 61000-4-8:2001
 RoHS: EN 50581:2012

Contact Us For More Information

Toll Free Tel: 1 (888) 626-4365 Fax: 1 (800) 263-5807	Local & International Tel: +1 (905) 363-2400 Fax: +1 (905) 363-1191	Canada 1799 Argentia Road Mississauga, Ontario L5N 3A2	USA 3790 Commerce Court, Suite 500, North Tonawanda New York, 14120	Online www.Lynch.ca sales@lynch.ca
--------------------------------------------------------------------	--------------------------------------------------------------------------------------	---------------------------------------------------------------------	-------------------------------------------------------------------------------------	-----------------------------------------------------------------------------------------------------------------------

LE PM X-1017

LE PM X

SETTINGS & RANGE GRAPHS

H: HIGH,
Maximum Current output, 0.10 to 3.00 [Amps]

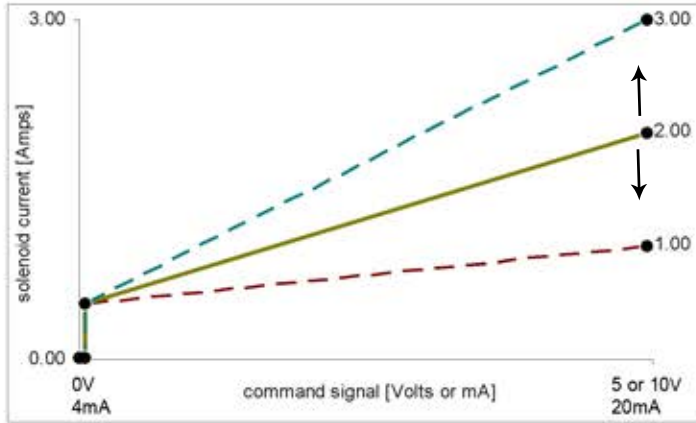

Lo: LOW,
Minimum Current Output, 0.00 to 2.99 [Amps]

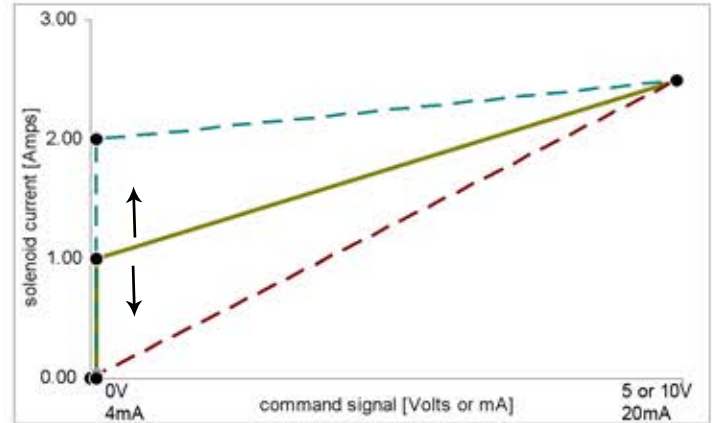

rUP: RAMP UP,
Time for Output to Increase from min to max, 0.0 to 99.5 [SEC]

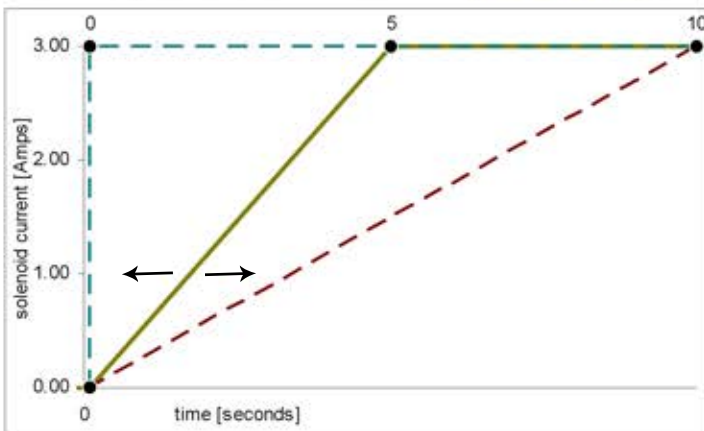

rDn: RAMP DOWN,
Time for Output to Decrease from max to min, 0.0 to 99.5 [SEC]

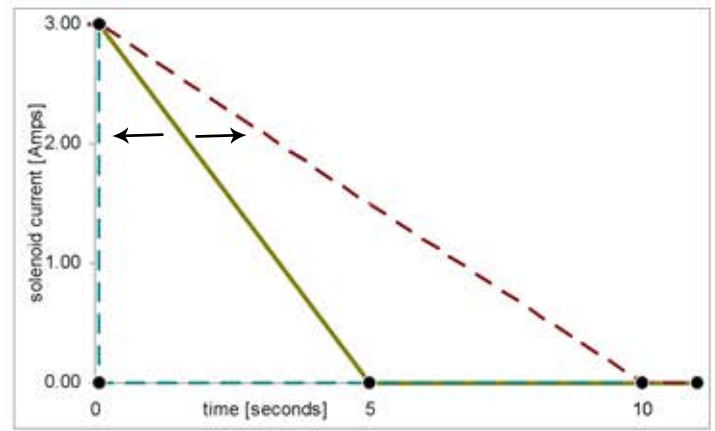

EdB: COMMAND DEADBAND,
Output disabled if command signal less than deadband, 0 to 5 [%]

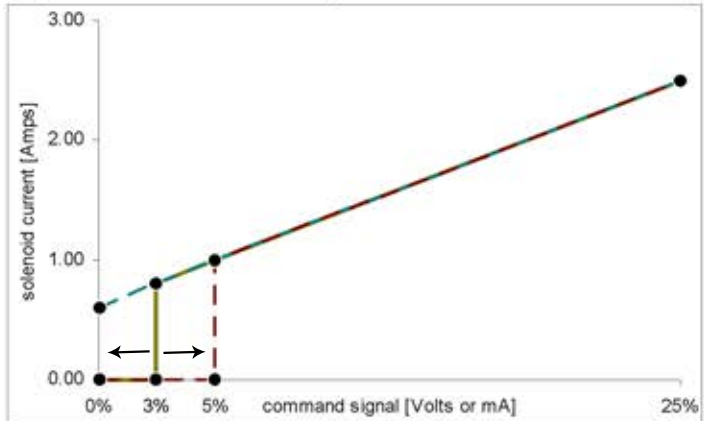

dFr: DITHER FREQUENCY,
40 (40Hz) to 450 (450Hz)

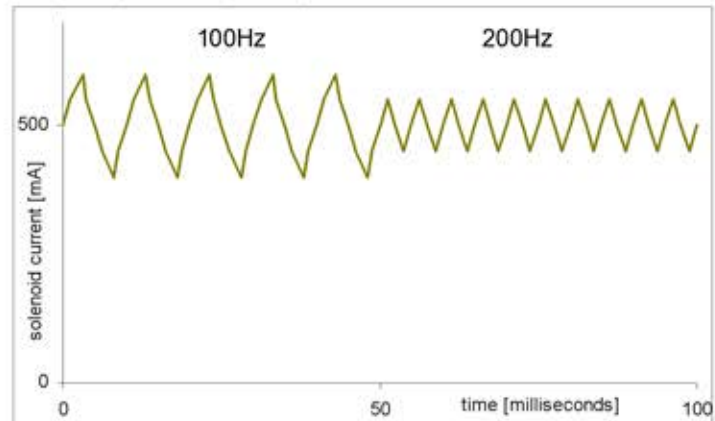

Contact Us For More Information

Toll Free Tel: 1 (888) 626-4365 Fax: 1 (800) 263-5807	Local & International Tel: +1 (905) 363-2400 Fax: +1 (905) 363-1191	Canada 1799 Argentia Road Mississauga, Ontario L5N 3A2	USA 3790 Commerce Court, Suite 500, North Tonawanda New York, 14120	Online www.Lynch.ca sales@lynch.ca
--------------------------------------------------------------------	--------------------------------------------------------------------------------------	---------------------------------------------------------------------	-------------------------------------------------------------------------------------	-----------------------------------------------------------------------------------------------------------------------

LE PM X

SET-UP PROCEDURE

(NOTE: Prior to setting up parameters, you must select proper Input Signal setting for your system)

Available Input Signal options

- in: 10 (0 to 10V) <=Default
- in: 5 (0 to 5V)
- in: 420 (4 to 20mA)

Applying improper Input Signal to wrong setting on the Driver may be damaging to Driver Unit and may cause driver to fault to Error Status mode

SET-UP

1. At power up, the display will show either the output current signal or the input signal (Default display setting shows the output signal). The decimal point will be flashing.
2. Rotate SELECT to enter the set-up mode.
3. When you reach the setting you want to modify, rotate ADJUST up or down to the desired value.
4. To modify another setting, rotate SELECT again and repeat.
5. The Driver is fully functional during the set-up procedure with any adjustments effective immediately.
6. In order to write the new settings in the memory and return to normal mode of operation, rotate SELECT until the display shows **SR** and then rotate ADJUST or wait for 100 seconds.
7. If you do not want to save the new settings you have just modified, you must disconnect the Driver from the power supply before the end of the 100 seconds to restore the previous settings.
8. After saving parameters to memory, the decimal point will be flashing and the Driver display will be back showing either the output current signal or input signal depending on your **di** selection.
9. To start over completely, you can restore the factory settings by rotating SELECT to **rFP** and then rotate ADJUST up past 10 for the display to reset. (NOTE for Step 9: You may have to adjust your Input Signal Setting again if you reset to factory settings).

SETTINGS & RANGE

- Hi**: HIGH, Maximum Current Output, 0.10 to 3.00 [Amps]
- Lo**: LOW, Minimum Current Output, 0.00 to 2.99 [Amps] (See: NOTE 1)
- rUP**: RAMP UP, Time for Output to Increase from min to max, 0.0 to 99.5 [SEC]
- rDN**: RAMP DOWN, Time for Output to decrease from max to min, 0.0 to 99.5 [SEC]
- cdB**: COMMAND DEADBAND, Output disabled if command signal less than deadband, 0 to 5 [%]
- dFr**: DITHER FREQUENCY, 40 (40Hz) to 450 (450Hz)
- in**: INPUT SIGNAL SELECTION, 5 (0 to 5V) or 10 (0 to 10V) or 420 (4 to 20mA)
- di**: DISPLAYED SIGNAL FOR TROUBLESHOOTING, 0 (command signal in [Volts] or [milliAmps]) or I (solenoid current in [Amps])
 Flashing decimal point is an indicator for present display mode
 -Fast Flashing decimal point, several flashes per second indicates **di** = 0
 -Slow Flashing decimal point, 1 per second indicates **di** = I
 -No Flashing decimal point or No decimal point indicates display in SETTING/ADJUST mode
- SR**: SAVE SETTINGS
- rFP**: RESET FACTORY PARAMETERS (See: NOTE 2)
- Err**: ERROR DETECTION STATE, Short Circuit, Reverse polarity protection and detection
 Error 0 - No Errors
 Error 1 - Overcurrent in driver likely due to short circuit in Solenoid
 Error 2 - Current exceeding 20mA in "4 to 20mA" input mode
- CLr**: CLEAR ERROR, Clears Driver of Error State (See: NOTE 2)

NOTE 1: When adjusting the **Hi** and **Lo** parameters, note the **Hi** parameter value cannot be adjusted below the **Lo** parameter value as well the **Lo** parameter value cannot exceed the **Hi** parameter value.

NOTE 2: Adjust Parameter Value up past 9 to operate this command setting.

OPTIONAL FEATURES (Please contact us for more information)

- Pcd**: PASSWORD, Adjust code for Password Protection settings for Lock or Unlock
- Loc**: LOCK, Locks driver to LOCKED state with Password set in **Pcd**
- UnL**: UNLOCK, Unlocks driver with correct Password set in **Pcd**
 Only available in LOCKED state mode